

The Company offers Two - year - warranty for repairing or replacing parts, free of cost against defects in manufacturing functional subject to the following terms and conditions.

- This warranty is valid only if this card is duly signed and stamped by our dealer and is produced along with the original customer's copy of the purchase bill.
- Warranty period starts from the date of purchase from our authorized dealer only.
- The appliance has to be used with all normal care and maintenance and in accordance with instructions for use recommended by the company, as enumerated in the instruction manual.
- The Appliance should not be repaired, tampered or altered by any agency or person other than an authorised company personal or their service centers.
- Plastic and glass parts, which are not covered under this warranty.
- The Appliances subject to normal wear & tear, misuse, neglect, accident including technical, breakdown etc. or non compliance of the instruction given in the instruction manual, improper installation is not covered by this warranty.
- The customer is responsible for bringing the defective product to the service centre / manufacturer for servicing and collecting the same at his/her own cost.
- The Appliances is meant for domestic use only.
- Parts repaired or replaced under this warranty are warranted only for the remainder of the original warranty period, that is not fresh warranty is limited shall commence for the said replaced / repaired part.
- Liability under terms of warranty is limited to the value of the repairs / replacement of the parts found to be defective within the warranty period. All parts may have been replaced, shall have been replaced, shall become the property of the company.
- Under the terms of warranty, installation, free service will be provided only within the municipal limits of the cities/to where the company has its branches or authorized representatives. Service outside the municipal limits specified above will be provided after charging the actual to and fro travelling and incidental expenses, as prevailing from time to time.
- This decision of the company is final and binding on all matters arising out of this warranty.
- This warranty is issued at Delhi, and courts at Delhi shall have exclusive jurisdiction over matters following from this warranty. In case of any dispute, arising out the same shall be settled by an Arbitrator, in accordance with the provision of Arbitration and condition Act. 1996.

		WARRANTY CARD		From The date of purchase
Product Name :	GEM Washing Machine			
Model Name :				
Serial No :				
(Dealer / Retailer to fill as per the details of sticker on your Product)				
Purchase Date :	(DD)	(MM)	(YYYY)	
Bill No. :				
Customer Name & Address :				
Dealer Name :				
Dealer's Name, Signature & Stamp		Customer's Signature		
I accept the Terms & Conditions of the Warranty				



EMPIRE HOME APPLIANCES LTD.
1/7, West Patel Nagar, New Delhi - 110008, INDIA
Tel: 91-11-25885791, 25885792
Email: info@gem.net.in



Customer Care
8882-650-660

 **GEM**
Designed To Organise

**USER MANUAL
WITH WARRANTY CARD**

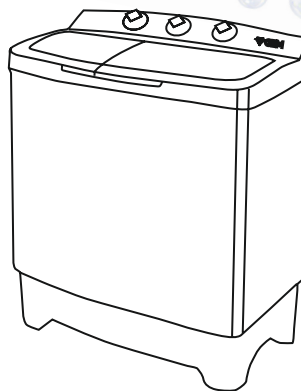
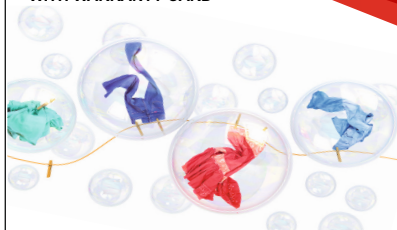

**HEALTH FOR YOU.
CARE FOR YOUR
FAMILY.**

Model No.
GWM85
GWM88
GWM90



RoHS
COMPLAINT

INSTRUCTION MANUAL

Please read this manual carefully before operating the machine

SAFETY MEASURES

Observe the following guidelines for the durability of the washing machine and safety problems.

- Do not expose the washing machine to direct sunlight or rain



- Do not install the washing machine around a damp place.

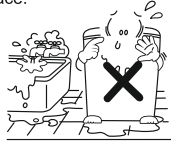

- Do not sprinkle water over the control panel switches.



- Do not plug many cords in one outlet at the same time.



- When plugging out the power cord, do not hold the wire.

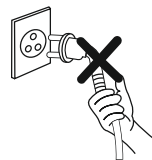

- Keep children away from the washing machine.



- Keep the Machine away from fire or heat source.



- Do not pour caustic soda & bleach over the washing machine. It causes damage to the rubber parts.



- Do not pour water with a temperature exceeding 50° C into the tub.



- Make sure of closing the lid, particularly during spinning.



- Do not put your hands into the rotating tub.



- Let water drain away from the drain hose thoroughly.



PRODUCT DESCRIPTION

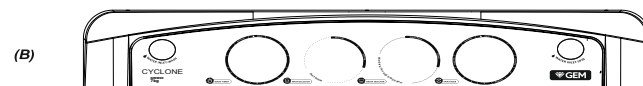
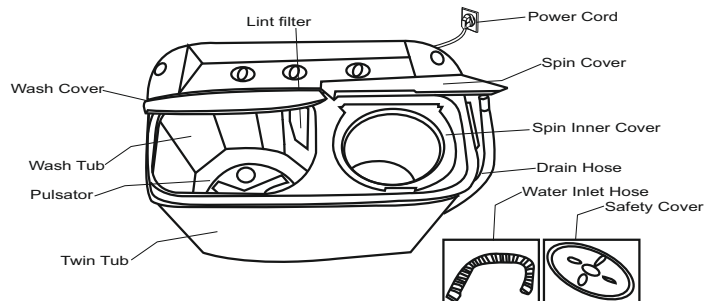

i) HOT & COLD WATER INLET

Connect here with the inlet hose from the water faucet to feed water to the tub
Wash Tub (Left) / Spin tub (Right)

ii) FEEDING WATER LABEL

When the water spills out of the hole under the label, it means too much water has supplied. Close the water tap and adjust the level.

iii) SPIN TIMER

Select the desired time for spinning. The maximum limit is 5 min., but shall not be continued over 3 cycle. Don't rotate the knob more than prescribed limit

iv) BUZZER:

End of Wash/Rinse cycle is indicated by cycle end buzzer.

v) DRAIN SELECTOR

Select "Wash + Rinse" for washing and rinsing and "Drain" to drain the water out of the tub.

vi) WASH SELECTOR

Set the program to "Normal", "Strong" according to kinds and quantity of the laundry.

vii) WASH TIMER

Select the desired time for washing or rinsing. The maximum is 15 min.

PRODUCT INSTALLATION

Installation area

- Set on flat and firm floor.
- Incorrect installation may cause severe noise and break down.



- Maintain more than 10 cm. between the side of drain hose and the wall.
- A carpet must not obstruct the ventilation openings.

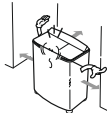

Connecting the earth wire

- Install the earth wire to prevent short-circuit due to leaking current and electric shock.
- It is attached at the back of the washer. Connect it to the metal water pipe. If the water pipe is made of plastic, it does not have the earth effect.
- Do not connect the earth wire to the gas pipe, lightning arrester, telephone connector, etc.

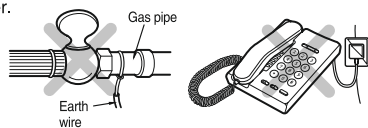

※ Warning-the appliance with two-pronged plug must be grounded.

Connecting the power plug

- Insert the power plug into the outlet.
- Before connecting the power plug, check if the voltage setting of the washer matches the outlet voltage.
- If AC outlet with ground terminal is used, grounding is not needed. If not, never forget earthing (earthing method above).
- The appliance must be positioned so that the plug is accessible.

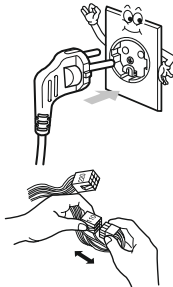

Voltage Change (only for dual voltage)

This washer is assembled for 230V, but can be changed from 230V to 110V. Check your electrical source and follow the diagram below to convert voltage.

Other earthing method

- After connecting the earth wire to the earth copper plate, bury it at least 75cm deep under the wet ground.
- Connect to the earthing-only outlet.
- When installing it in an area where earthing is not possible, purchase a short-circuit breaker connect it to the outlet.

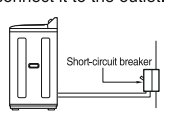
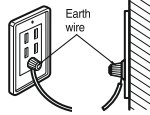
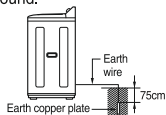

Care and Maintenance

Be sure to remove the power plug from main power supply before cleaning the machine and filter

Cleaning the Lint Filter

1. Pull out the lint filter from the lock use fingers pull out at the part of the Lint Filters side.
2. Turn the net inside out and clean with water.
3. Set back to the original position. Insert the bottom first as shown press down and lock as the arrow.

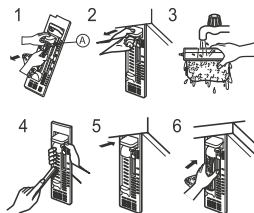

E-WASTE GUIDELINES

Declaration of Conformity with the requirements of the E-waste (Management) Rules, 2016. The Product is in conformity with the requirements of the reduction of hazardous substances of the E-waste (Management) Rules, 2016. The content of hazardous substance with the exemption of the applications listed in SCHEDULE II of the E-waste (Management) Rules, 2016:

1. Lead (Pb) – not over 0.1% by weight;
2. Cadmium (Cd) – not over 0.01% by weight;
3. Mercury (Hg) – not over 0.1% by weight;
4. Hexavalent chromium (Cr⁶⁺) – not over 0.1% by weight;
5. Polybrominated biphenyls (PBBs) – not over 0.1% by weight;
6. Polybrominated diphenyl ethers (PBDEs) – not over 0.1% by weight

For the purpose of recycling to facilitate effective utilization of resources, please return this product to a nearby authorized collection center, registered dismantler or recycler, or 'Empire Home Appliances Pvt. Ltd.' service center when disposing of this product. Please see the www.gemindia.in website

EMPIRE HOME APPLIANCES PVT. LTD.
1/7, WEST PATEL NAGAR,
OPPOSITE METRO PILLAR 205, DELHI-110008.



How to Wash

Before washing

1. Check the washing instruction labels on the clothing to be washed.
2. Remove all objects from the pockets of the clothing. Objects left in the pockets may damage clothing or break the washing machine (could cause the drain hose to clog).
3. Wash After separating oiled and dyed clothing.
4. For your convenience hang up the wash cover on the right or left side of the washing machine tub when not in use.

Remove this before washing



1. Set the knob to "WASH / RINSE".
2. Fill the tub with water according to the weight of cloth (Refer table 1 and 2).
3. Put the clothes in the tub. Do not put an excessive amount of laundry, in the tub. (Refer table 1 and 2).
4. Put recommendable quantity of detergent as mentioned in Table 1.
5. Set the Wash Selector to NORMAL & STRONG mode as you desired
6. Set Wash Time up to 15min, depending on your cloth load & type (Refer Table 2).
7. When washing is completed, drain off the washing water by adjusting the knob to "DRAIN" position.
8. After the washing water is discharged, turn the knob switch to "WASH / RINSE" position.
9. Fill the water up to the desired level for rinsing.

Note: Water level may be less than the water level line while washing. If so, refill the water. Be careful not to exceed the indicated water level line; it may cause water to spill out of the tub.

How to Spin/Rinse

Interim spin rinse

- Interim spin rinse prior to regular rinsing helps removing sudsy water from the laundry and improve rinsing efficiency. Also is helpful to water saving.

1. After washing. Move the laundry into the spin dryer basket. Place the safety cover horizontally on the laundry.
2. Connect inlet hose to water supply inlet in Spin tub
3. Set the desired spin flow appropriately.
4. After interim spin rinse, move the laundry into the wash tub for rinsing.



Note for spinning

1. Put the laundry evenly into the spin dryer basket.
2. Put the laundry down lightly.
3. Place the safety cover horizontally over the laundry, washing machine will be damage if the safety cover is not placed.
4. Close the spin dryer cover.
5. Do not drain the water out of the wash tub while the spin dryer basket is in operation.
- If the spin dryer basket is off-balance and vibrates excessively, stop the spinning, rearrange the clothes evenly, and then resume spinning.
- If the spinning fail to stop when the spin dryer cover is opened, the brake is out of order. Immediately stop using the machine and request repair service.



LAUNDRY GUIDE

TABLE 1. DETERGENT GUIDE

WASH LOAD	1.2 kg	1.2~2.5 kg	2.5~3.8 kg	3.8~5.0 kg	5.0 kg or ABOVE
Water Level	Min.	Low	Medium	High	Over Flow
Amount of concentrate Detergent	20 gm	30 gm	40 gm	50 gm	60 gm
Amount of Softener	20 ml	25 ml	30 ml	35 ml	40 ml
Amount of Water	25 Ltr	40 Ltr	51 Ltr	63 Ltr	67 Ltr

Table 2- LAUNDRY GUIDE

Amount of Laundry	Clothes			
	System	Synthetic Fiber	Cotton	Heavy Stained Clothes
1.2 ~ 2.5 kg	Washing Time	2~5 minutes	7~10 minutes	10-15 Minutes
	Wash Selector	NORMAL	STRONG	STRONG
2.5 ~ 3.8 kg	Washing Time	7~10 minutes	10~15 minutes	Wash 15 minutes
	Wash Selector	NORMAL	STRONG	STRONG
3.8 kg and above	Washing Time	Wash 10~15 minutes	Wash 15 minutes	Wash 15 minutes
	Wash Selector	NORMAL	STRONG	STRONG

Table 3: GUIDE FOR SPINNING

Spin Time (min.)	Type of Fabric
2 ~ 3	Synthetics, Silk, Woolen, Knits
3 ~ 4	Cotton, Linen
4 ~ 5	Very soiled, cotton and linen

- Amount of laundry is based on dry laundry.
- Detergent amount is based on a general synthetic detergent.
- If washing and spinning must be operated together, starting washing and spinning operation shall be done at the same time to cope with EMC requirement

TROUBLESHOOTING GUIDE

Before Requesting Service

Problem	Checking point
Motor does not operate,	<ul style="list-style-type: none"> ● Is the power cord firmly plugged in? ● Is the timer turned to a suitable point except "OFF" ?
Spin dryer basket does not operate.	<ul style="list-style-type: none"> ● Is there any clothing dropped between the basket and tub? ● Is the spin dryer cover closed? ● Is the laundry gathered to one side of the spin dryer basket?
No draining For Non-Pump Model For Pump Model	<ul style="list-style-type: none"> ● Is there lint stuck in the plunger valve? ● Is the end of the drain hose guide located at an exceed height? ● Is the drain pump operated?